

ZEP2 - 340LF2 CW

340 - LED 150 W



- **Type:** Single lens luminaire
- **Source:** LED 150 W
- **Optics:** 200 mm Fresnel lens
- **Colour temperature:** Cool White

Single lens

Low running costs, high performance

Equipped with an enhanced white LED source providing a higher output with a significant efficiency, this 200 mm Fresnel lens presents an exceptional flat and variable beam angle with very wide opening, combined with an electronic flicker-free dimmable PSU to create a powerful yet economical LED washlight. Perfect for TV studio, theatre, event and architectural applications.

Features

- **Theatre front cassette:** no light spill to distract audiences or performers
- **Colour runners:** double runners to hold accessories and colour filters
- **Barn door:** unique rotating barn door with 4 individually rotating blades – makes even the most difficult angle possible
- **Remote setup:** all parameters can be adjusted by RDM protocol
- **Adjustable response time:** choice of fast or slow dimming for tungsten-like simulation
- **DMX:** 8 or 16 bit dimming and strobe function
- **Local setup:** DMX address and mode, dimming curve and response time through 4-button display with automatic light switch-off
- **Control:** local, DMX, wireless DMX (option)
- **Focus reference:** index for easy focus reference
- **Focus adjustment:** smooth focus adjustment from rear
- **Tilt reference on hanging yoke:** index for rapid re-positioning

Optical

- **Unique 200 mm (8 in) lens:** no equivalent on the market in terms of light output and beam quality
- **Wide angle:** up to 90° from edge to edge
- **Beam shaping :** efficient barndoors in any focus position
- **Electronic dimmer:** dimming without clipping or cut-out at low intensity levels; high quality smoothing
- **No colour shift:** colour temperature remains the same when dimming

Construction

- **Made in France :** fully manufactured in Robert Juliat premises retaining complete control over all aspects of quality
- **PSU:** built-in electronic flicker-free power supply for easy, plug-and-play installation
- **Power connectors:** neutriK® powerCON TRUE1 TOP IN and OUT connectors for daisy chaining
- **Silent-running cooling fans:** ideal for TV studios and opera houses
- **Electronic thermal management system:** ensures maximum performance of the system without any risk of overheating
- **Bodywork:** strong sheet metal construction for durability
- **Captive knobs and handles:** additional security when working at height or in transit
- **Safety first:** front accessories safety cable attachment point

Picture:340LF + CF1000

DSEN337_340LF2_CW - 17/06/2021

Robert Juliat reserves the right to change or alter any of the items detailed on this page, to increase or improve manufacturing techniques without prior notice.

Robert Juliat S.A.S., 32 rue de Beaumont, 60530 Fresnoy-en-Thelle - France
Telephone : +33 (0)3 44 26 51 89 - fax : +33 (0)3 44 26 90 79 - info@robertjuliat.fr
www.robertjuliat.com



ROBERT JULIAT

Source

- Lamp type: LED
- Power: 150 W

| LED specifications | Power * | Lumen output* | Colour temperature* | Life* | CRI* (min) |
|-----------------------------|---------|---------------|---------------------|-----------|------------|
| SUHD60/2 V3 CW (RJ / Osram) | 150 W | 16 170 lm | 5700K | 100 000 h | 92 |

(*) manufacturer's data

Optics

Characteristics

- Type: Single lens
- Beam range: 11° to 68°
- Lens: 200 mm Fresnel lens

Gel filter

- Shape: Square
- Standard size: 215x215 mm (8.5x8.5 in)

Photometrics

with SUHD64 CW W (RJ / Osram) source

• Optics @ 11°

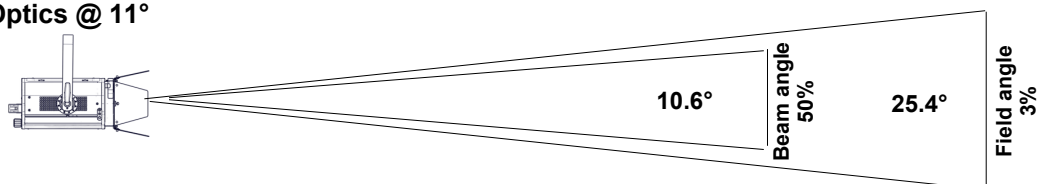

Beam intensity
95 500 cd

| | | | | | | |
|--------------|------------|-----------|-----------|---------|---------|---------|
| Distance | 3 m | 5 m | 7 m | 10 m | 12 m | 15 m |
| Diameter | 1.4 m | 2.3 m | 3.2 m | 4.5 m | 5.4 m | 6.8 m |
| Illumination | 11 000 lux | 3 850 lux | 1 950 lux | 960 lux | 670 lux | 430 lux |
| Distance | 10 ft | 15 ft | 25 ft | 35 ft | 40 ft | 50 ft |
| Diameter | 4.5 ft | 6.8 ft | 11.3 ft | 15.8 ft | 18 ft | 22.5 ft |
| Illumination | 960 fc | 430 fc | 160 fc | 80 fc | 60 fc | 39 fc |

CCT
8 000 K

• Optics @ 68°

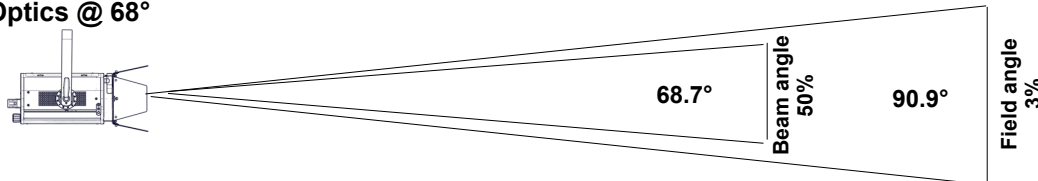

Beam intensity
9 100 cd

| | | | | | | |
|--------------|-----------|---------|---------|---------|---------|----------|
| Distance | 3 m | 5 m | 7 m | 10 m | 12 m | 15 m |
| Diameter | 6.1 m | 10.2 m | 14.2 m | 20.3 m | 24.4 m | 30.5 m |
| Illumination | 1 050 lux | 370 lux | 190 lux | 95 lux | 65 lux | 41 lux |
| Distance | 10 ft | 15 ft | 25 ft | 35 ft | 40 ft | 50 ft |
| Diameter | 20.3 ft | 30.5 ft | 50.8 ft | 71.1 ft | 81.3 ft | 101.6 ft |
| Illumination | 95 fc | 41 fc | 15 fc | 8 fc | 6 fc | 4 fc |

CCT
7 500 K

Remote control

- Data protocol: USITT DMX512-A
RDM

- Data IN connector: 5 pins XLR male
- Data OUT connector: 5 pins XLR female

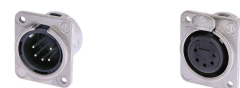

• DMX chart:

Mode 1 (1 channels)

Dimmer

Mode 2 (4 channels)

Dimmer
Dimmer fine
-
Strobe

Mode 3 (5 channels)

Dimmer
Dimmer fine
-
Strobe
Dimmer master

Dimensions and weight

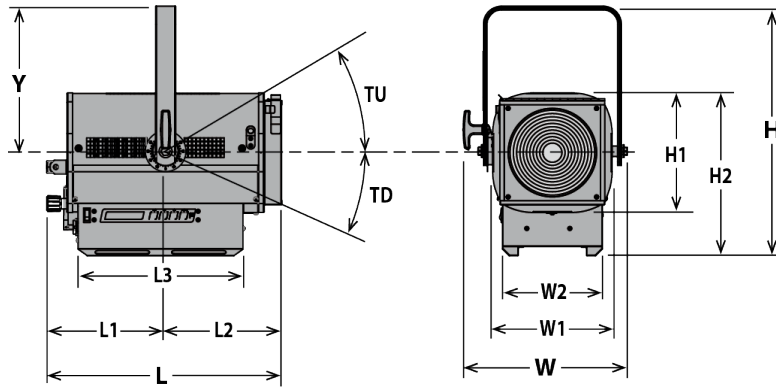

Weight: 14.2 kg (31.2 lbs)

| Height | Length | Width | Yoke | Tilt |
|----------------------|----------------------|---------------------|---------------------|---------|
| H= 520 mm (20.5 in) | L= 494 mm (19.4 in) | W= 344 mm (13.5 in) | Y= 303 mm (11.9 in) | TU= 90° |
| H1= 250 mm (9.8 in) | L1= 250 mm (9.8 in) | W1= 250 mm (9.8 in) | | TD= 90° |
| H2= 342 mm (13.5 in) | L2= 244 mm (9.6 in) | W2= 210 mm (8.3 in) | | |
| | L3= 346 mm (13.6 in) | | | |

Shipping

- **Weight :** 19.5 kg (42.9 lbs)
- **Volume :** .09 m³ (3.18 ft³)

Installation

- **Minimum distance to illuminated surface:** 0.2 m (0.5 ft)
- **Operating position:**

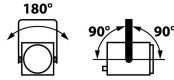

Construction

- **Housing:** Steel sheet - Aluminium
- **Colour:** Black
- **Cooling:** Low noise variable fan
- **Maximum ambient temperature (Ta):** 40°C (104°F)
- **Maximum case temperature (Tc):** 65°C (149°F)
- **Total heat dissipation:** 631 BTU/h
- **Ingress Protection (IP) rating:** IP20

Electrical compatibility

- 220/230 V - 50 Hz
- 220/230 V - 60 Hz
- 245 V - 50 Hz
- 100 V - 50 Hz
- 110/120 V - 60 Hz
- 100 V - 60 Hz
- 208 V - 60 Hz
- Selector: automatic detection

Power input



- **Type:** removable power cord with Neutrik powerCON TRUE1 TOP connector (included)
- **Cable:** H07RNF 3G1.5
- **Length:** 3 m (9.8 ft)
- **Power connector:** CEE 7/7 (2P+E NF/Schuko)

Power consumption

| Voltage | Frequency | Current | Power | Power factor |
|---------|-----------|---------|-------|--------------|
| 230 V | 50 Hz | 0.8 A | 185 W | 95 |
| 120 V | 60 Hz | 1.5 A | 185 W | 98 |
| 100 V | 60 Hz | 1.8 A | 185 W | 98 |

Power Supply Unit

- **PSU:** Internal - Electronic PSU - Flicker free with PFC
- **Control:** Local / DMX
- **Protection:** Mains: 4A 1P1D breaker - UL /
- **Power thru:** Neutrik powerCON TRUE1 TOP - Maximum of 19 units (230 V) / 10 units (120 V)

Warranty

- **Fixture: 3 years - Source: 5 years**
See General Sales Condition on website

Approvals





Acoustics

- **Noise level:** < 22,7 dB(A)







Model

| | |
|------------------|---|
| 340LF2 CW | LED 150 W Single lens luminaire - 200mm Fresnel - 340LF2 CW ZEP2 - Cool White |
|------------------|---|

Options

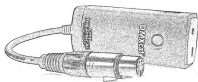
| | | |
|-----------------|---|---|
| PCP1716A | 16A blue 2P+E 6h IEC60309 power connector |  |
| PO/Z | Pole operation yoke (PAN/TILT/Focus) | |
| W-DMX/ZF | W-DMX wireless DMX |  |

Accessories

| | | |
|-----------------|---|---|
| PF1000M2 | 215x215mm metal filter holder 1 included |  |
| CF1000 | 4 rotating leaves on a rotating barndoor - 215x215mm (without safety cable) - Poids: 1.03 Kg |  |
| DMXcat | Bluetooth DMX/RDM Multifunction test tool - City Theatrical DMXcat® |  |
| 876 | Hook clamp 40x10mm with 28mm M10 screw for Ø35 to 50mm pipes - SWL: 50Kg - Poids: 1.25 Kg |  |
| 880 | Hook clamp 40x10mm with 28mm M10 screw for Ø50 to 63mm pipes - SWL: 50Kg - Poids: 1.36 Kg |  |
| CS2 | Safety cable Ø3 mm L= 600mm - SWL: 75 Kg |  |
| CS5 | Safety cable Ø1,5 mm L=300mm for front accessory with karabiner and quick link - SWL: 25 Kg |  |